

# huddlebox edge inspiration

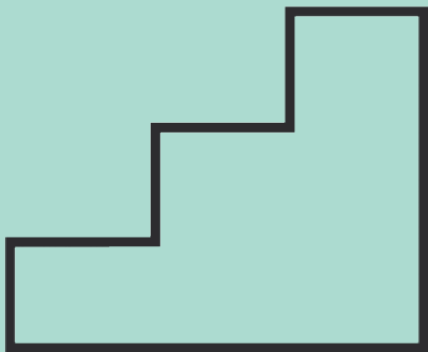

**workagile**  
MAKING SPACES AGILE

# Be Inspired

We understand the importance of cost-effectiveness for businesses of all sizes, and that's why we have designed Huddlebox Edge with an emphasis on delivering exceptional value, without compromising quality.

By offering a scalable seating solution at a budget-friendly price point, Edge allows teamwork and productivity to be boosted without breaking the bank.

“Huddlebox Edge is our most affordable tiered seating option, with larger sized modules that make the system more cost effective.”



# Finishing Touches

## MFC Options

MFC is a cost effective construction option, with limited finishes available



Light Grey



Anthracite



Black



Birch



Light Oak

## Ply Options

Our ply finishes enhance office wellness through a fresh, organic look and feel



Plywood

## Fabric Options



Camira	Auga	Inloom
Advantage Era Gravity Manhattan Phoenix Rivet	Juno Libra Linetta	Alba Bondai Erika One



Camira	Auga	Inloom
Aspect Honeycomb Main Line Flax Main Line Plus Oceanic Xtreme X2	Aura UV Cashmir Nova Oregon Hyde	Jeans Jet King Flex Milano Riva Roccia



Camira	Auga	Inloom
24/7 Flax Blazer Halcyon Hemp Silk Synergy	Cord Finezza Pearl Verd Eco	Alba Bondai Erika One



Camira	Kvadrat
Synergy Quilt Channel Synergy Quilt Chevron Synergy Quilt Hourglass	Canvas Divina 3 Fiord

For the complete range of fabrics, please email: [london@work-agile.com](mailto:london@work-agile.com) or call us on 020 3904 6688, and we can advise a price.

# 1

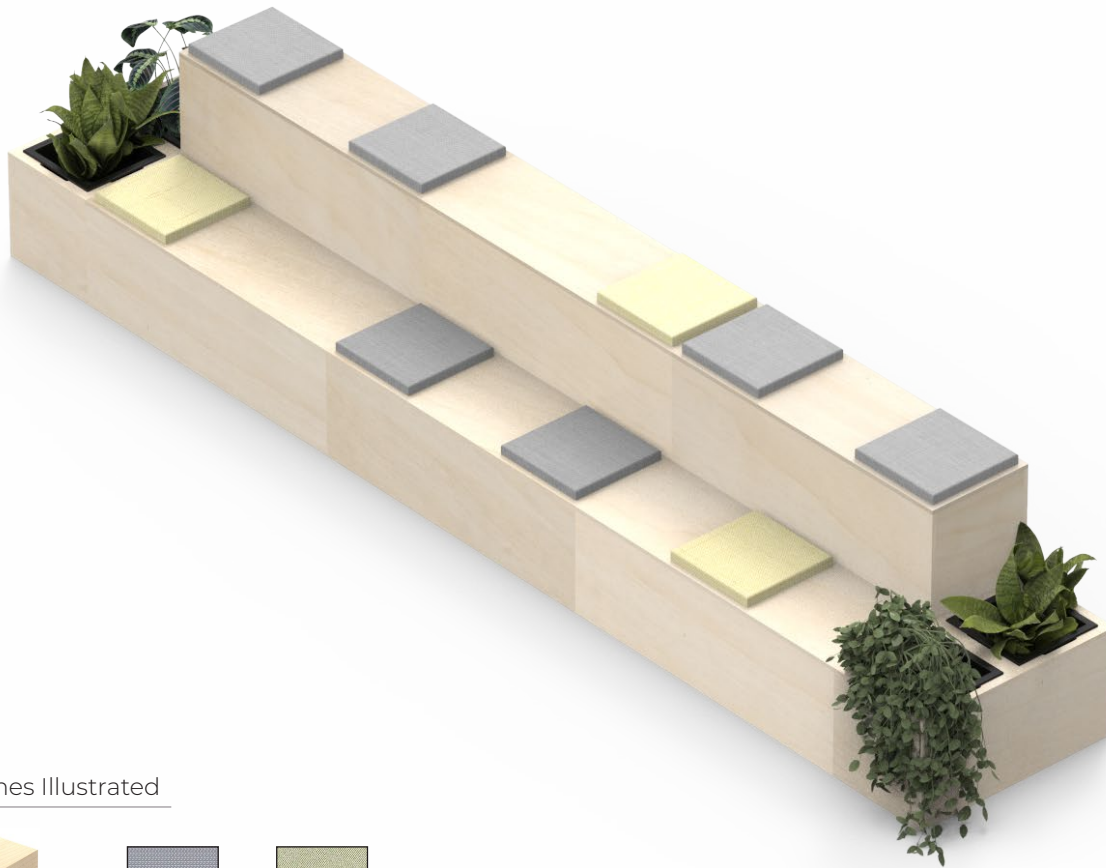

### Finishes Illustrated



Plywood



Camira Era, Analogue



Camira Manhattan, Varick

### Modules Used



Module 5 Edge Planter x 2



Module 9 Edge Large x 3

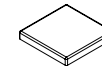

Single Seat Pads x 9

### Overall Config Dimensions (WxDxH)

4950mm x 900mm x 900mm

### Accommodation

Seats up to 9 People

### RRP Price for configuration pictured

Modules in MFC, Seapads in band 1 fabric **£8,445**

Modules in Plywood, Seapads in band 1 fabric **£12,605**

\*Planting not included, only plant liners included with configuration.

# 2

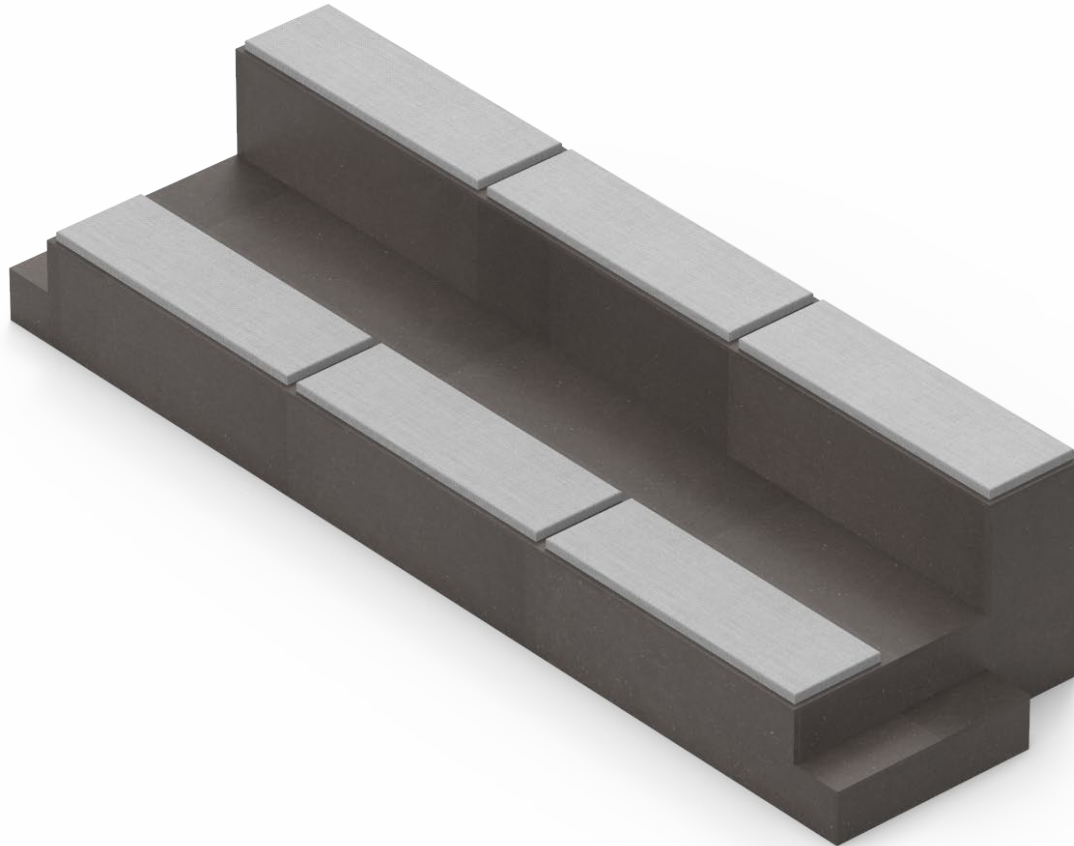

Anthracite



Camira  
Gravity,  
Frost

## Modules Used



Module 1 Edge

x 2



Module 11 Edge Large

x 3

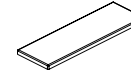

Triple Seat Pads

x 6

## Overall Config Dimensions (WxDxH)

4500mm x 1350mm x 900mm

## Accommodation

Seats up to 18 People

## RRP Price for configuration pictured

Modules in MFC,  
Seatpads in band 1 fabric **£9,512**



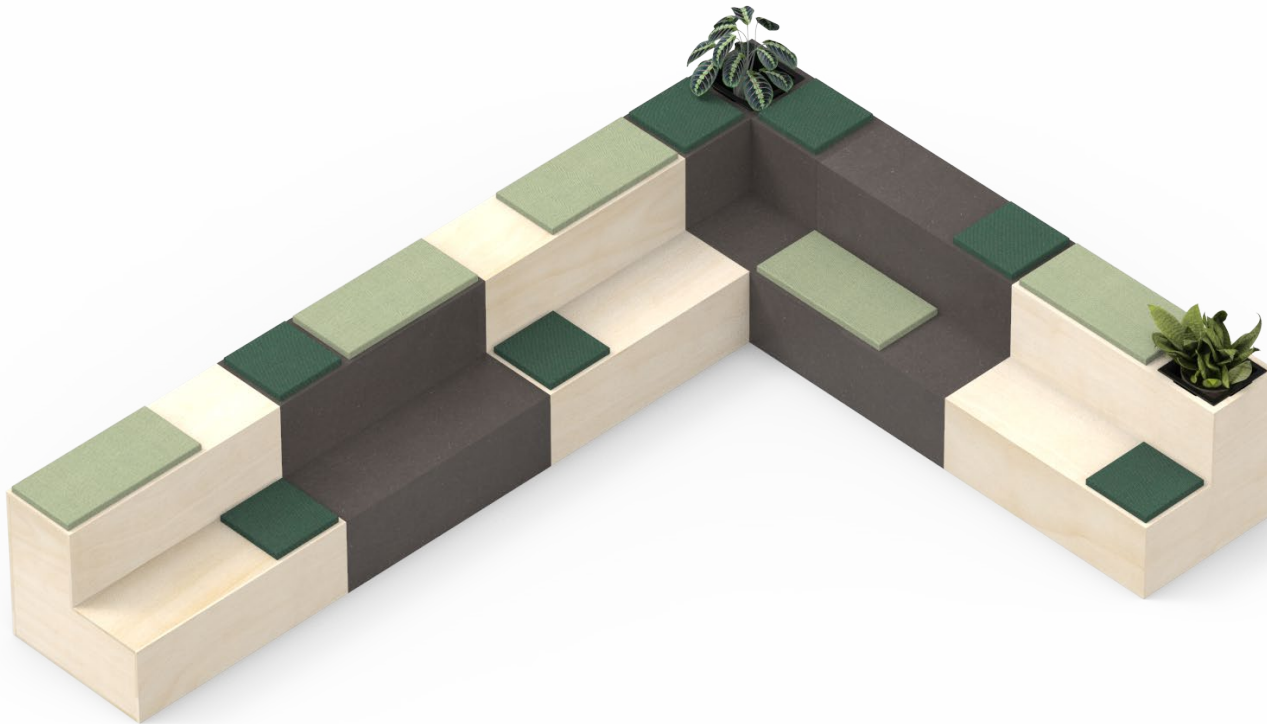

Modules in Plywood,  
Seatpads in band 1 fabric **£14,552**

\*Planting not included, only plant liners included with configuration.

# 3

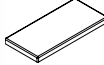

### Modules Used

	Module 9 Edge Large	x 5
	Module 10 Edge	x 1
	Double Seat Pads	x 6
	Single Seat Pads	x 7
	Custom Planter Cutout	x 2

### Overall Config Dimensions (WxDxH)

4950mm x 3600mm x 900mm

### Accommodation

Seats up to 16 People

### RRP Price for configuration pictured

Modules in MFC, Seapads in band 1 fabric	<b>£13,554</b>
Modules in Plywood, Seapads in band 1 fabric	<b>£20,434</b>

\*Planting not included, only plant liners included with configuration.



Anthracite



Plywood



Camira  
Advantage,  
Aztec





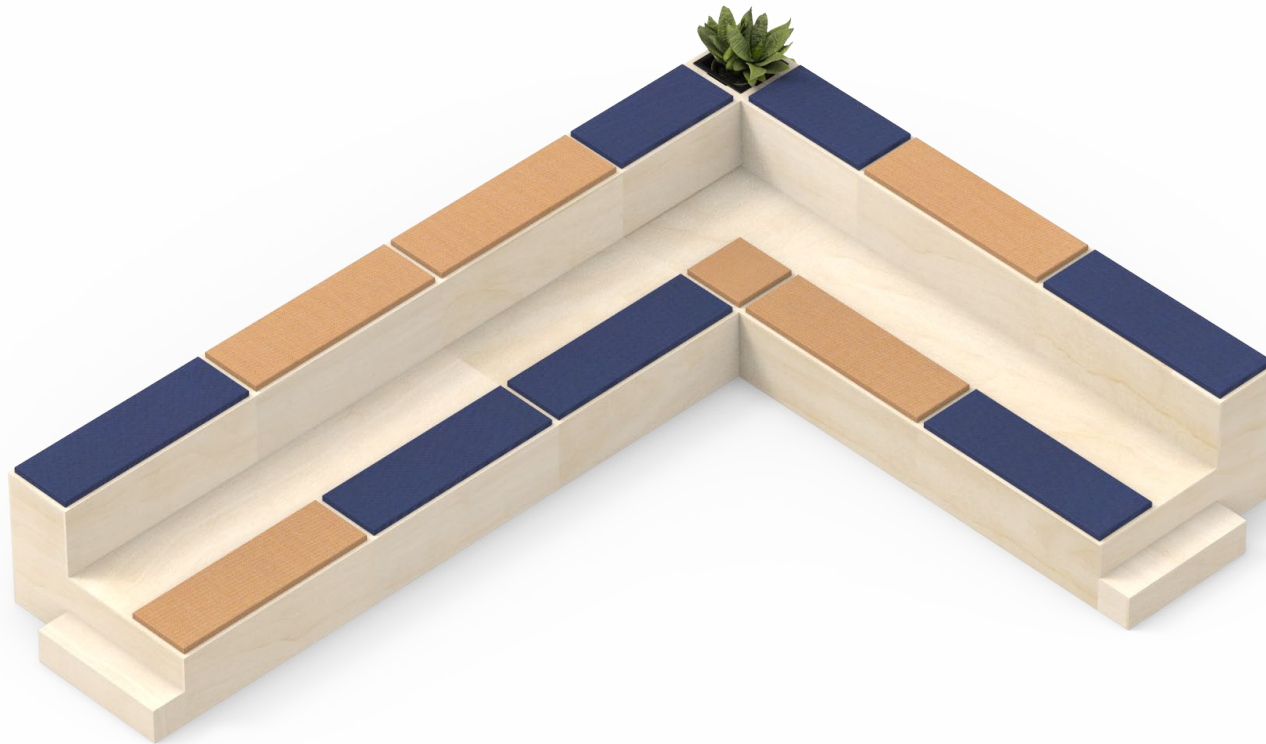

Camira  
Rivet,  
Burnish

# 4

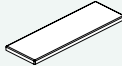
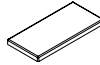

### Modules Used

	Module 1 Edge	x 2
	Module 11 Edge Large	x 5
	Module 12 Edge	x 1
	Triple Seat Pads	x 10
	Double Seat Pads	x 2
	Single Seat Pads	x 1
	Custom Planter Cutout	x 1

### Overall Config Dimensions (WxDxH)

5625mm x 4275mm x 900mm

### Accommodation

Seats up to 34 People

### RRP Price for configuration pictured

Modules in MFC, Seapads in band 1 fabric	£19,424
Modules in Plywood, Seatpads in band 1 fabric	£28,585



Plywood



Camira Gravity, Brook



Camira Gravity, Sunni

\*Planting not included, only plant liners included with configuration.

# 5

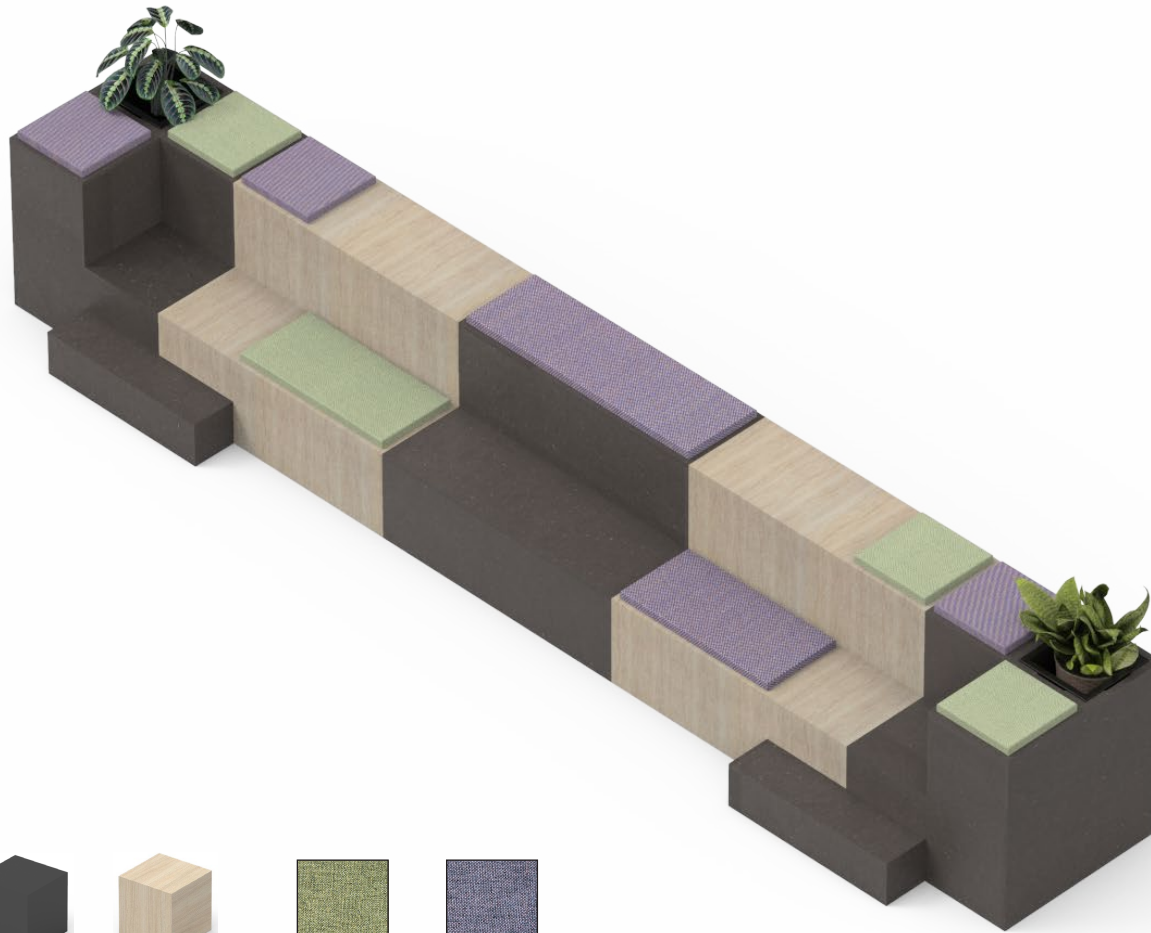

Anthracite









Light Oak



Camira Rivet, Burnish



Camira Rivet, Fuse

Modules Used		
	Module 1 Edge	x 2
	Module 9 Edge Large	x 3
	Module 10 Edge	x 2
	Triple Seat Pads	x 1
	Double Seat Pads	x 2
	Single Seat Pads	x 6
	Custom Planter Cutout	x 2

### Overall Config Dimensions (WxDxH)

5850mm x 900mm x 900mm

### Accommodation

Seats up to 11 People

### RRP Price for configuration pictured

Modules in MFC, Seapads in band 1 fabric **£11,369**

Modules in Plywood, Seatpads in band 1 fabric **£17,126**

\*Planting not included, only plant liners included with configuration.



# 6

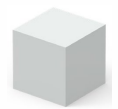
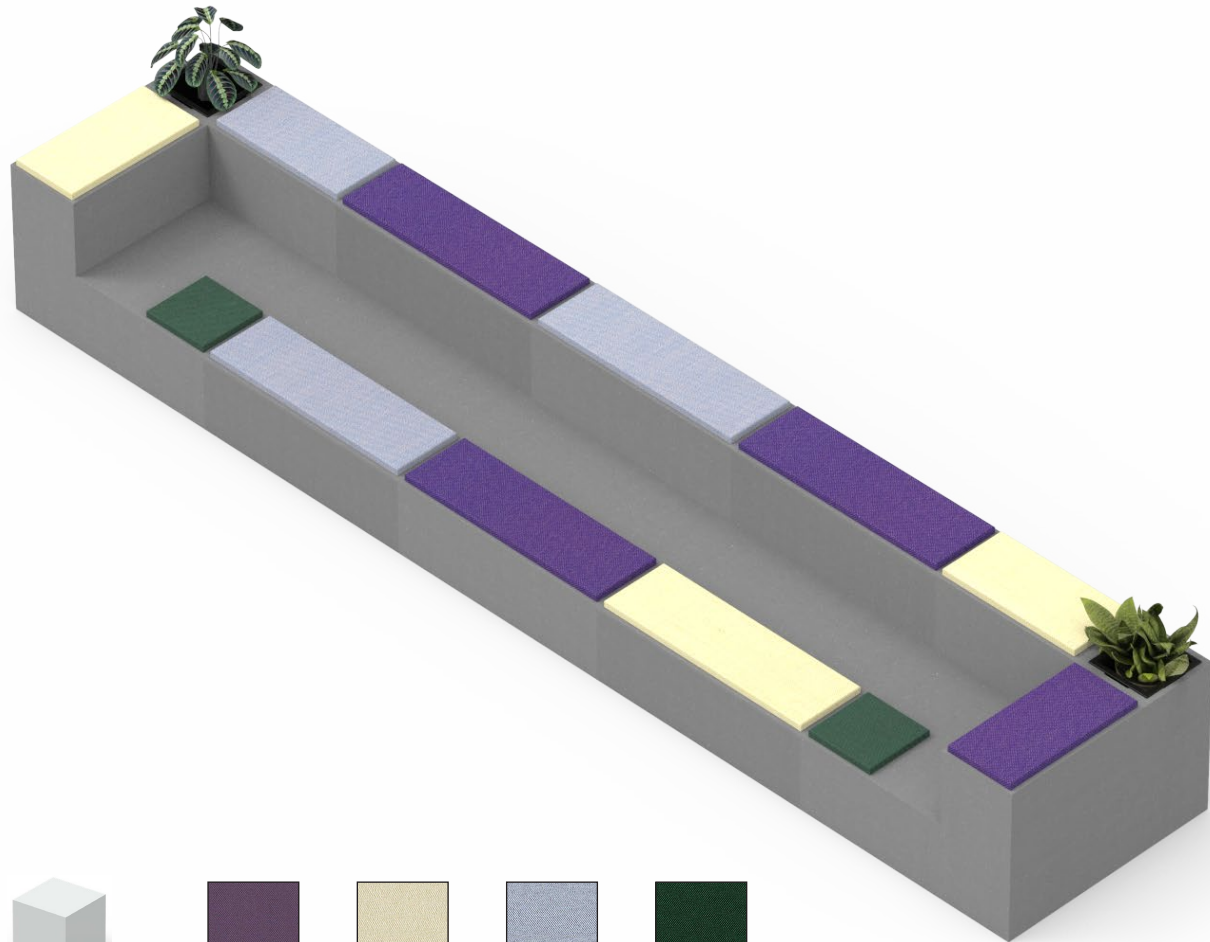

Light Grey



Camira Era, Prime



Camira Era, Transition



Camira Era, Youth



Camira Era, Signature

## Modules Used



Module 11 Edge Large x 3



Module 12 Edge x 2

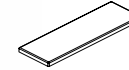

Triple Seat Pads x 1

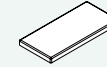

Double Seat Pads x 2

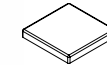

Single Seat Pads x 6



Custom Planter Cutout x 2

## Overall Config Dimensions (WxDxH)

6750mm x 1350mm x 900mm

## Accommodation

Seats up to 26 People

## RRP Price for configuration pictured

Modules in MFC,  
Seapads in band 1 fabric **£16,880**

Modules in Plywood,  
Seatpads in band 1 fabric **£23,792**

\*Planting not included, only plant liners included with configuration.

# 7

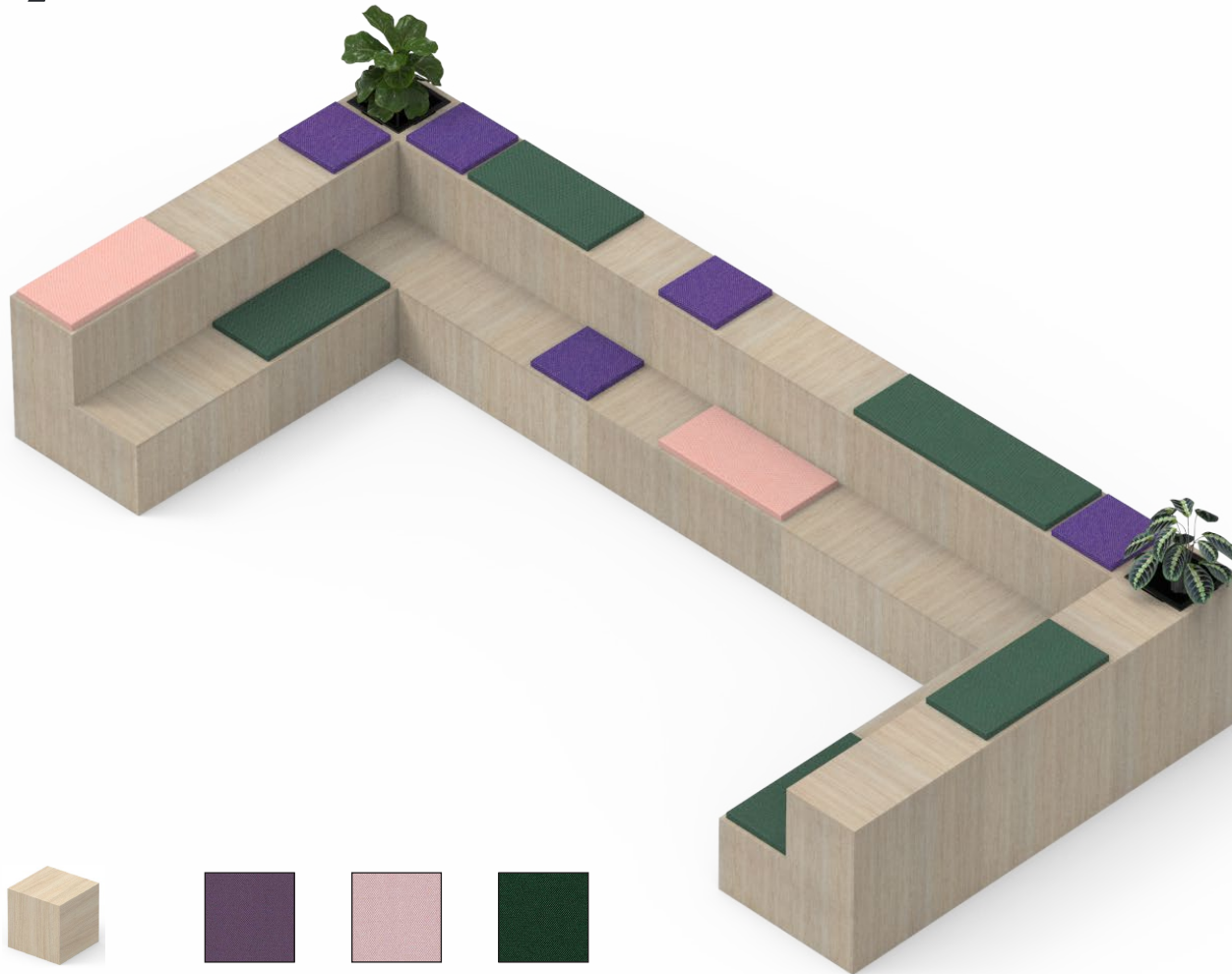

Light Oak



Camira Era, Prime







Camira Era, Calander

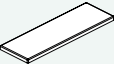
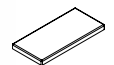
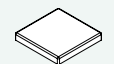

Camira Era, Signature

### Modules Used

	Module 9 Edge	x 4
	Module 9 Edge Large	x 3
	Module 10 Edge	x 2
	Triple Seat Pads	x 1
	Double Seat Pads	x 6
	Single Seat Pads	x 5
	Custom Planter Cutout	x 2

### Overall Config Dimensions (WxDxH)

5850mm x 2700mm x 900mm

### Accommodation

Seats up to 19 People

### RRP Price for configuration pictured

Modules in MFC, Seapads in band 1 fabric	<b>£17,102</b>
Modules in Plywood, Seatpads in band 1 fabric	<b>£26,696</b>

\*Planting not included, only plant liners included with configuration.

# 8

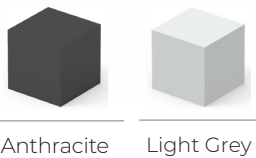
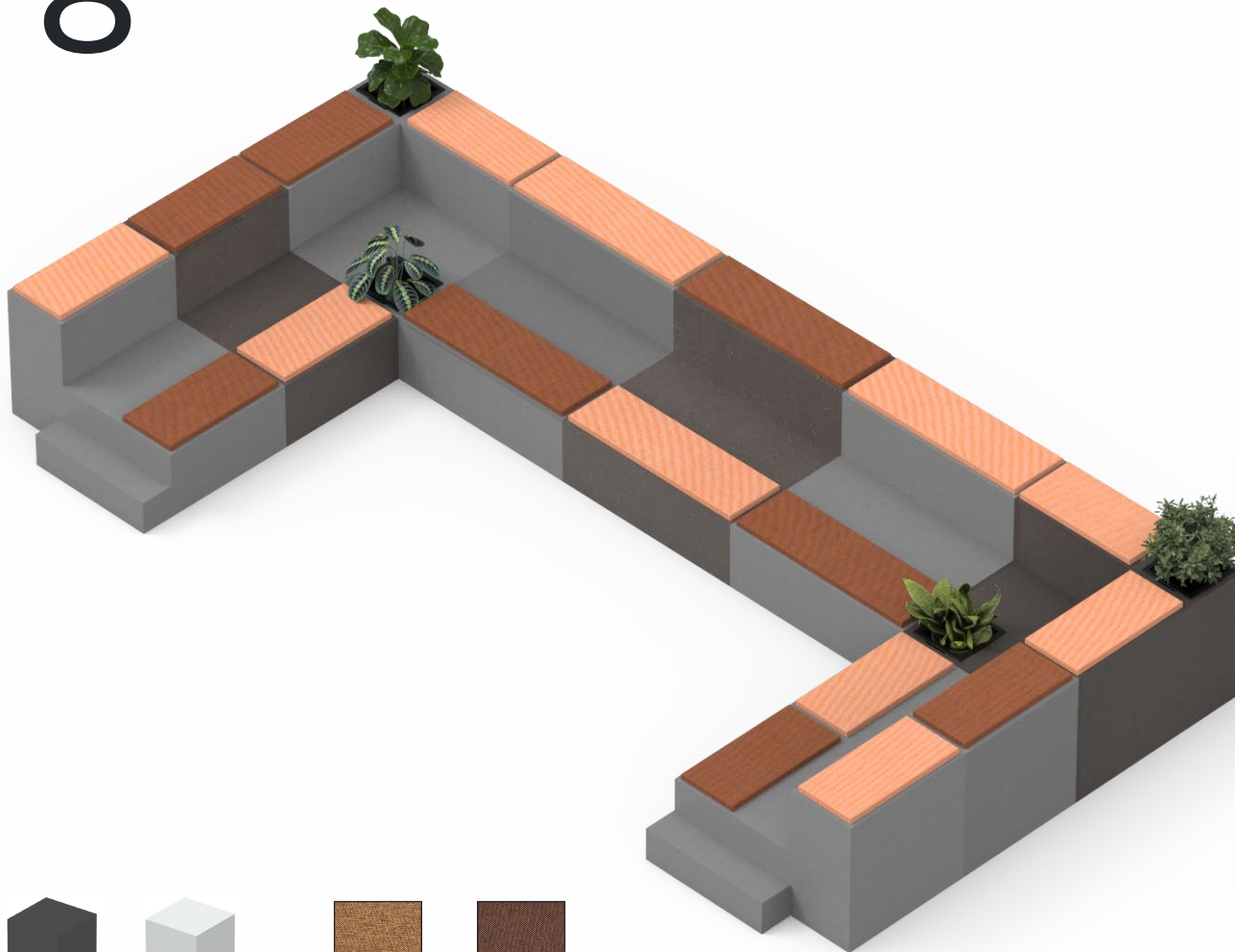







Anthracite    Light Grey

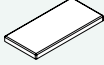

Camira Rivet, Copper    Camira Rivet, Deep Clay

### Modules Used

	Module 1 Edge	x 2
	Module 11 Edge	x 4
	Module 11 Edge Large	x 3
	Module 12 Edge	x 2
	Triple Seat Pads	x 6
	Double Seat Pads	x 12
	Custom Planter Cutout	x 4

### Overall Config Dimensions (WxDxH)

6750mm x 3375mm x 900mm

### Accommodation

Seats up to 40 People

### RRP Price for configuration pictured

Modules in MFC, Seapads in band 1 fabric	<b>£26,498</b>
Modules in Plywood, Seapads in band 1 fabric	<b>£38,610</b>

\*Planting not included, only plant liners included with configuration.

**Can't find what you  
want? Contact us for  
a free configuration  
drawing today!**

[london@work-agile.com](mailto:london@work-agile.com)

02039046688

[work-agile.com](http://work-agile.com)

**workagile**

MAKING SPACES AGILE