

**workagile**

MAKING SPACES AGILE



Huddlebox<sup>®</sup>

Edge



## Specifications

+44 (0)20 3904 6688

[london@work-agile.com](mailto:london@work-agile.com)

[work-agile.com](http://work-agile.com)

# Standard modules

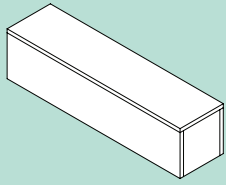

## MODULE 1

Width: 900mm  
Depth: 225mm  
Height: 225mm

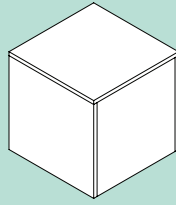

## MODULE 2

Width: 450mm  
Depth: 450mm  
Height: 450mm

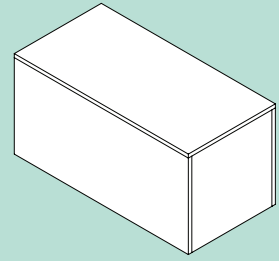

## MODULE 5

Width: 900mm  
Depth: 450mm  
Height: 450mm

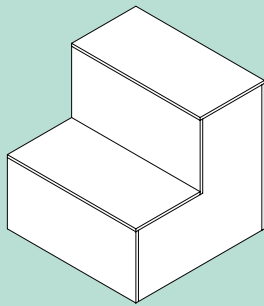

## MODULE 9

Width: 900mm  
Depth: 900mm  
Height: 900mm

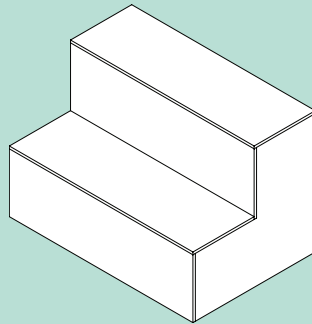

## MODULE 9 LARGE

Width: 1350mm  
Depth: 900mm  
Height: 900mm

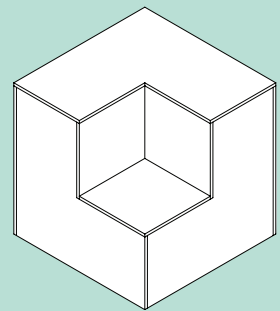

## MODULE 10

Width: 900mm  
Depth: 900mm  
Height: 900mm

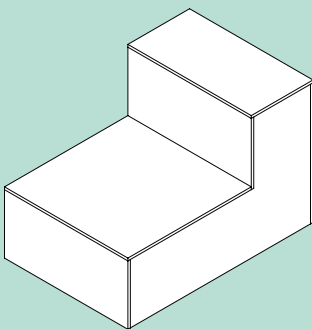

## MODULE 11

Width: 900mm  
Depth: 1350mm  
Height: 900mm

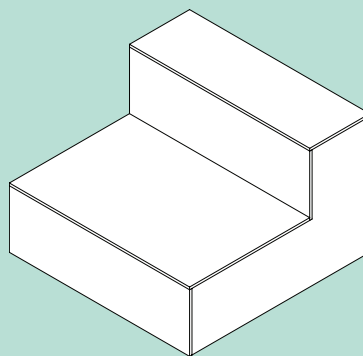

## MODULE 11 LARGE

Width: 1350mm  
Depth: 1350mm  
Height: 900mm

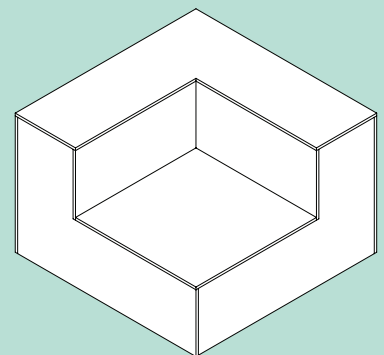

## MODULE 12

Width: 1350mm  
Depth: 1350mm  
Height: 900mm

# Planter modules

Supplied with plastic liner - suitable for real or artificial plants

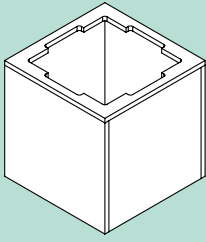

## MODULE 2 PLANTER

Width: 450mm  
Depth: 450mm  
Height: 450mm

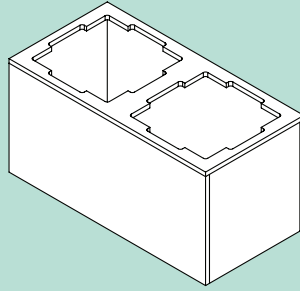

## MODULE 5 PLANTER

Width: 900mm  
Depth: 450mm  
Height: 450mm

# Cubby Modules

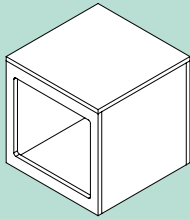

## MODULE 2 CUBBY

Width: 450mm  
Depth: 450mm  
Height: 450mm

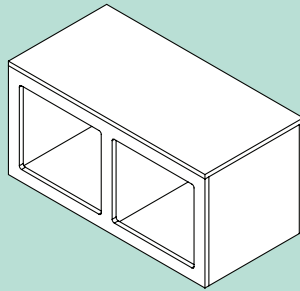

## MODULE 5 CUBBY

Width: 900mm  
Depth: 450mm  
Height: 450mm

# Seat Options



---

## SINGLE SEAT PAD

Width: 400mm  
Depth: 400mm  
Height: 50mm



---

## DOUBLE SEAT PAD

Width: 400mm  
Depth: 400mm  
Height: 50mm



---

## TRIPLE SEAT PAD

Width: 400mm  
Depth: 400mm  
Height: 50mm



---

## SINGLE SEAT

Width: 400mm  
Depth: 488mm  
Height: 490mm

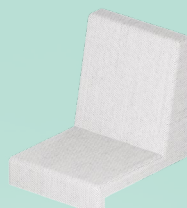

---

## SINGLE SEAT SQUARE

Width: 400mm  
Depth: 488mm  
Height: 490mm



---

## DOUBLE SEAT

Width: 850mm  
Depth: 488mm  
Height: 490mm



---

## DOUBLE SEAT SQUARE

Width: 850mm  
Depth: 488mm  
Height: 490mm

# Optional Extras



## HUDDLEBOX SQUARE TABLE

The perfect place to set a laptop, notepad, or even a cup of tea



## HUDDLEBOX ROUND TABLE

The perfect place to set a laptop, notepad, or even a cup of tea

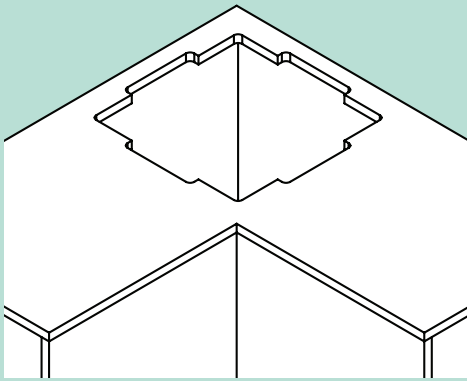

## PLANTER CUTOUT (PLANT LINER INCLUDED)

Biophilic designs bring nature indoors, promoting calmness

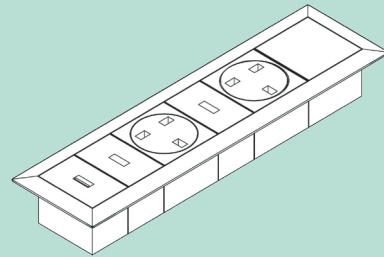

## POWER MODULE

Stay powered up with an integrated power module.



## LOCKABLE CASTORS

Castors available for easy moving and to protect flooring



## ANTI-MICROBIAL SURFACE

Anti-microbial lacquer for extra safety and hygiene

# Finishing touches

## Ply Options

Our ply finishes enhance office wellness through a fresh, organic look and feel.



PLYWOOD

## MFC Options

MFC is a cost effective construction option, with limited finishes available.



LIGHT GREY



ANTHRACITE



BLACK



BIRCH



LIGHT OAK

# Seat Pad fabric options

## Band 1

Camira	Auga	Inloom
Advantage	Juno	Alba
Era	Libra	Bondai
Gravity	Linetta	Erika
Manhattan		One
Phoenix		
Rivet		

## Band 2

Camira	Auga	Inloom
Aspect	Aura UV	Jeans
Honeycomb	Cashmir	Jet
Main Line Flax	Nova	King Flex
Main Line Plus	Oregon Hyde	Milano
Oceanic		Riva
Xtreme		Roccia
X2		

## Band 3

Camira	Auga	Inloom
24/7 Flax	Cord	Alba
Blazer	Finezza	Bondai
Halcyon	Pearl	Erika
Hemp	Verd Eco	One
Silk		
Synergy		

## Band 4

Camira	Kvadrat
Synergy Quilt Channel	Canvas
Synergy Quilt Chevron	Divina 3
Synergy Quilt Hourglass	Fiord

For the complete range of fabrics, please email: [london@work-agile.com](mailto:london@work-agile.com) or call us on 020 3904 6688, and we can advise a price.

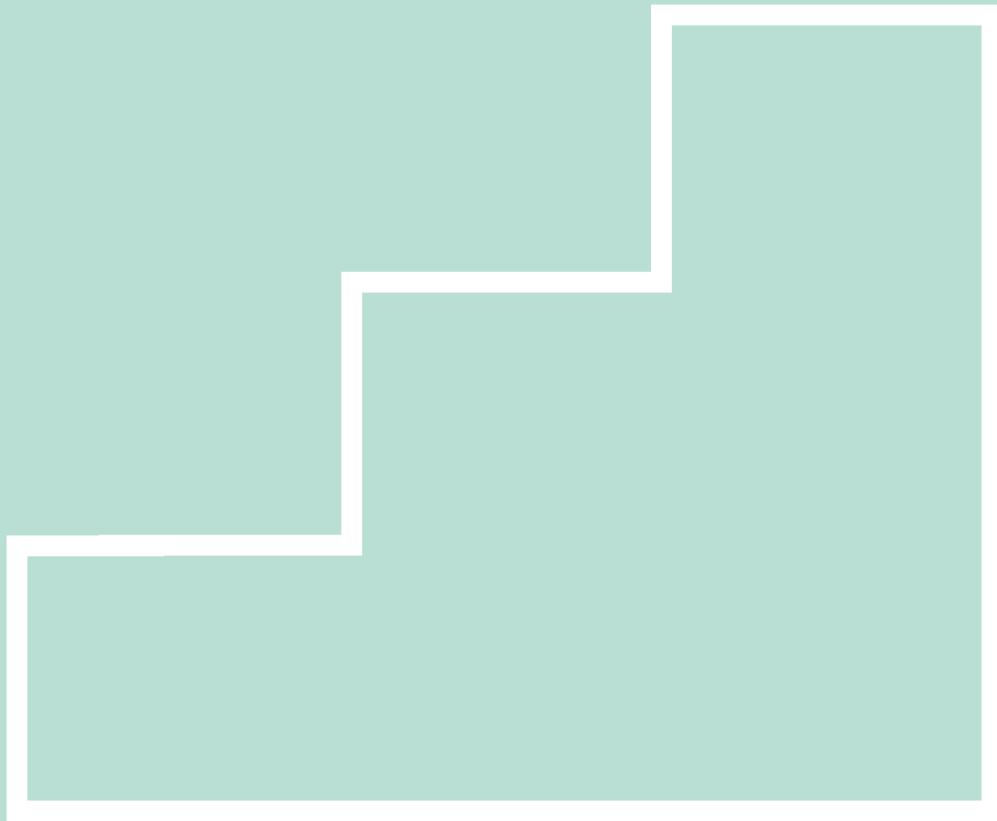
**UK Head Office**

Pineapple House, Westmead,  
Aylesford, Maidstone, ME206XJ

**France**

13 rue Louis Aragon, ZI La Vignasse,  
07800 La Voulte sur Rhône

**London Showroom**

41 Pear Tree Street, Clerkenwell,  
London, EC1V 3AG

**Leeds Showroom**

Vitality House, Milford Place,  
Leeds, LS4 2BQ

**USA**

7015 19 Mile Road  
Sterling Heights, MI 48314

**Germany**

Auf der Landeskronen 2,  
57234 Wilnsdorf

+44 (0)20 3904 6688

[london@work-agile.com](mailto:london@work-agile.com)

[work-agile.com](http://work-agile.com)