

workagile

MAKING SPACES AGILE

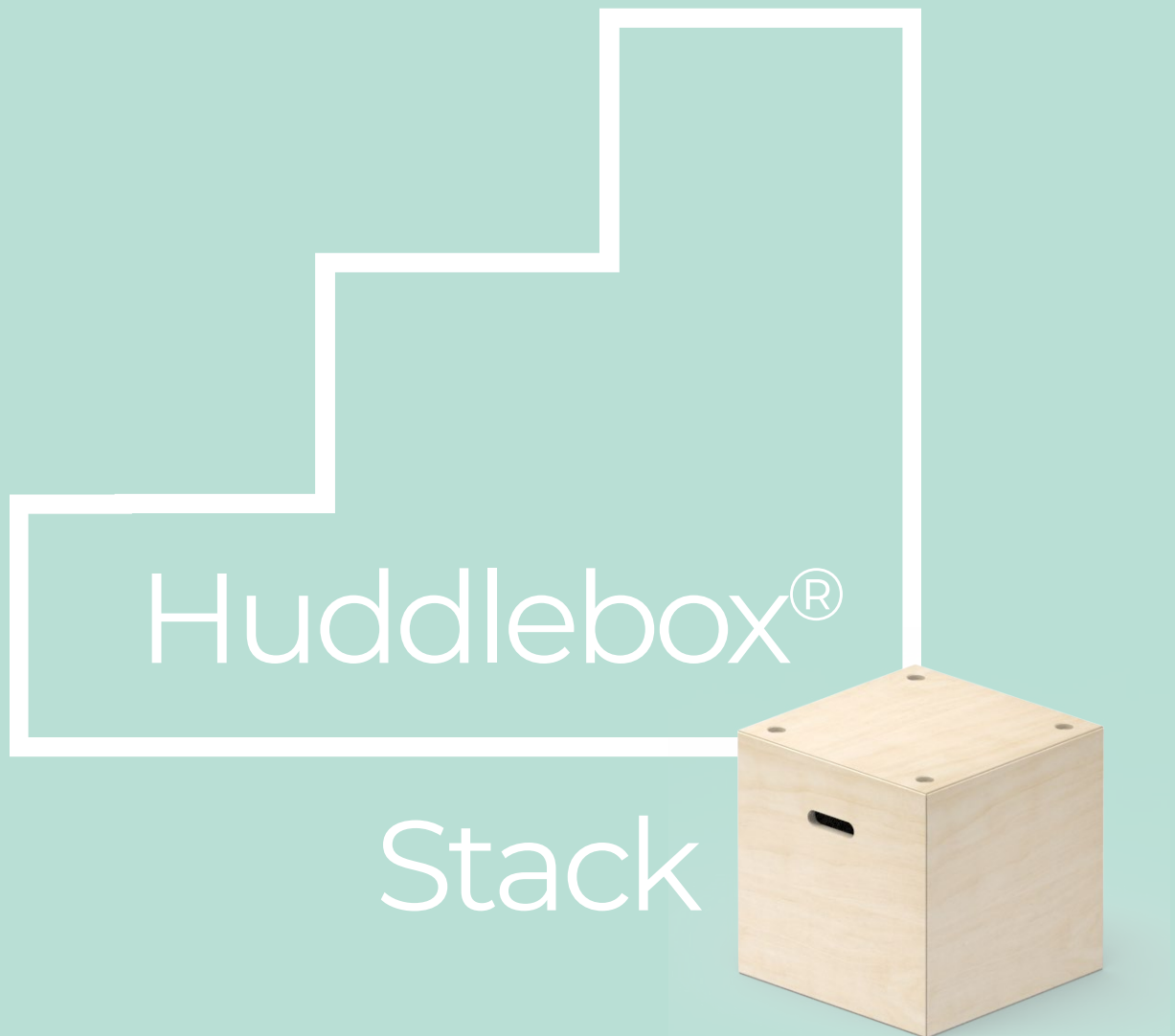

Specifications

+44 (0)20 3904 6688

london@work-agile.com

work-agile.com

Specification

- CUT OUT HANDLES TO AID HANDLING
- LOCATOR HOLES FOR RE-STACKING AND RE-CONFIGURING
- RUBBER FEET AS STANDARD ON ALL MODULES & SEAT PADS
- CONSTRUCTED FROM 18MM SUBSTRATE (MDF, PLYWOOD, FIBREBOARD)
- SIGNATURE HUDDLEBOX EDGE DETAIL

Standard Modules

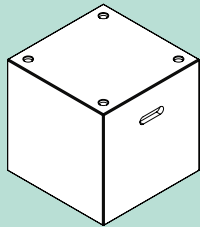

MODULE 2

Width: 450mm
Depth: 450mm
Height: 450mm

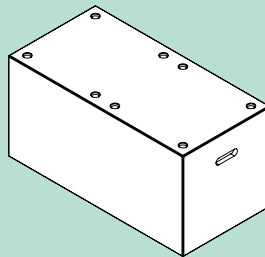

MODULE 5

Width: 900mm
Depth: 450mm
Height: 450mm

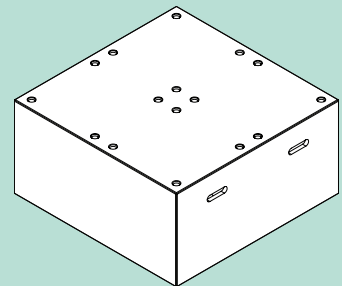

MODULE 6

Width: 900mm
Depth: 900mm
Height: 450mm

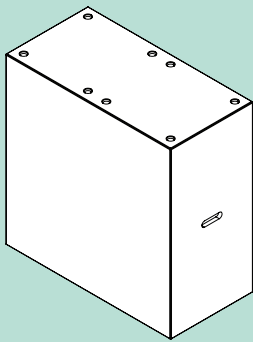

MODULE 7

Width: 900mm
Depth: 450mm
Height: 900mm

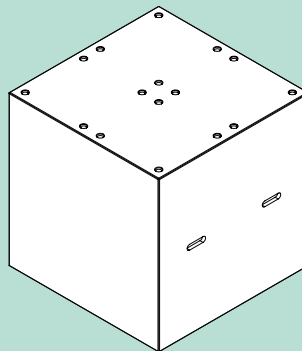

MODULE 8

Width: 900mm
Depth: 900mm
Height: 900mm

Storage modules

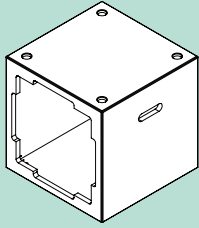

MODULE 2 CUBBY

Width: 450mm
Depth: 450mm
Height: 450mm

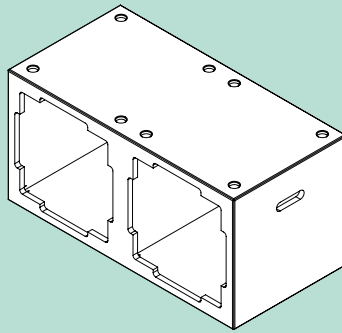

MODULE 5 CUBBY

Width: 900mm
Depth: 450mm
Height: 450mm

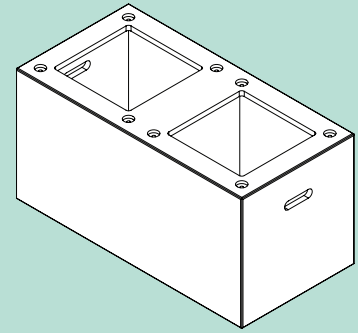

MODULE 5 BASIC STORE

(Seatpad acts as storage lid)

Width: 900mm
Depth: 450mm
Height: 450mm

Planter Modules

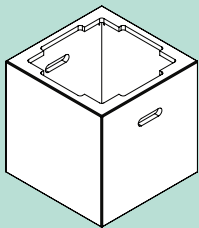

MODULE 2 PLANTER

(Plant liner included)

Width: 450mm
Depth: 450mm
Height: 450mm

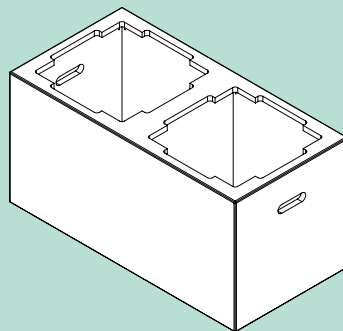

MODULE 5 PLANTER

(Plant liner included)

Width: 900mm
Depth: 450mm
Height: 450mm

Accessories



SINGLE SEAT PAD

Width: 400mm
Depth: 400mm
Thickness: 50mm



DOUBLE SEAT PAD

Width: 850mm
Depth: 400mm
Thickness: 50mm



SINGLE SEAT

Width: 400mm
Depth: 488mm
Height: 490mm



SINGLE SEAT SQUARE

Width: 400mm
Depth: 488mm
Height: 490mm



DOUBLE SEAT

Width: 850mm
Depth: 488mm
Height: 490mm



DOUBLE SEAT SQUARE

Width: 850mm
Depth: 488mm
Height: 490mm



TROLLEY

Width: 1105mm
Depth: 510mm
Height: 770mm



CADDY

Width: 900mm
Depth: 450mm
Height: 96mm



HUDDLEBOX SQUARE TABLE

The perfect place to set a laptop, notepad, or even a cup of tea



HUDDLEBOX ROUND TABLE

The perfect place to set a laptop, notepad, or even a cup of tea



LOCKABLE CASTORS

Castors available for easy moving and to protect flooring



ANTI-MICROBIAL SURFACE

Anti-microbial lacquer for extra safety and hygiene



PLANTER LINER (FOR REAL OR ARTIFICIAL PLANTS)

Biophilic designs bring nature indoors, promoting calmness

Finishing touches

Veneer Options

Veneer finishes are a more economical option to achieve a natural wood finish similar to ply.



BIRCH VENEER



OAK VENEER



PLYWOOD

Ply Options

Our sustainable ply finishes enhance office wellness through a fresh, organic look and feel.

Fibreboard Options

Coloured through fibreboard allows for consistent colouring across joints, and greatly reduces the visibility of any natural wear that occurs over the product's lifetime

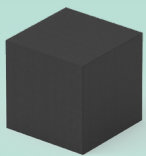

MIDNIGHT

Band 1

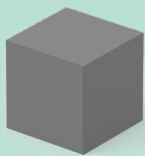

URBAN

Band 1



SAHARA

Band 2

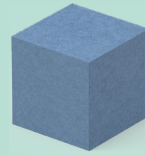

OCEAN

Band 2



CHILLI

Band 2

Laminate Options

Laminate is a durable, easy to clean option for adding colour to the top or all sides of your modules



BIRCH

Band 1



BLACK

Band 1



HAMILTON OAK

Band 1



LIGHT OAK

Band 1



STONE GREY

Band 1



COASTAL OAK

Band 2



CONCRETE

Band 2



DARK CONCRETE

Band 2



ELEGANCE ENGRAIN OAK

Band 2



NORDIC WOOD

Band 2



SAND GRANGE OAK

Band 2

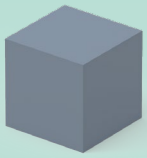

ALBY BLUE

Band 3



CAPPUCCINO

Band 3

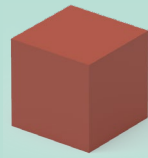

CEREMIC RED

Band 3

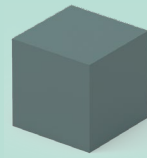

DARK EMERALD

Band 3

Forbo Linoleum Options

A satin matt surface with a warm, fine texture, that looks and feels truly distinctive. Antistatic properties help prevent adhesion of dust and dirt.

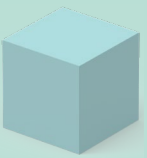

AQUAVERT



ASH

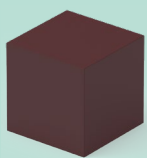

BURGUNDY

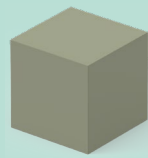

OLIVE

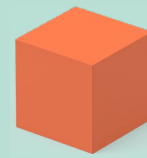

ORANGE



PEARL



PEBBLE

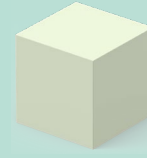

PISTACHIO



POWDER



SALSA

Seat Pad fabric options

Band 1

Camira	Auga	Inloom
Advantage	Juno	Alba
Era	Libra	Bondai
Gravity	Linetta	Erika
Manhattan		One
Phoenix		
Rivet		

Band 2

Camira	Auga	Inloom
Aspect	Aura UV	Jeans
Honeycomb	Cashmir	Jet
Main Line Flax	Nova	King Flex
Main Line Plus	Oregon Hyde	Milano
Oceanic		Riva
Xtreme		Roccia
X2		

Band 3

Camira	Auga	Inloom
24/7 Flax	Cord	Alba
Blazer	Finezza	Bondai
Halcyon	Pearl	Erika
Hemp	Verd Eco	One
Silk		
Synergy		

Band 4

Camira	Kvadrat
Synergy Quilt Channel	Canvas
Synergy Quilt Chevron	Divina 3
Synergy Quilt Hourglass	Fiord

For the complete range of fabrics, please email: london@work-agile.com or call us on 020 3904 6688, and we can advise a price.

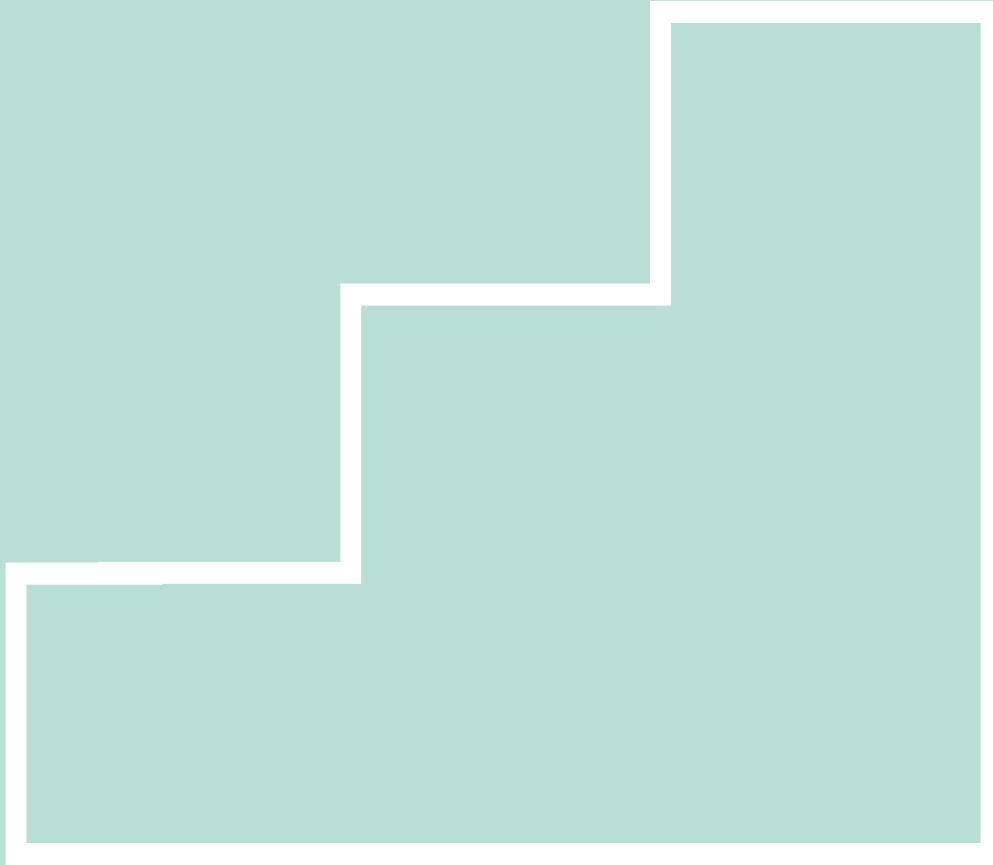
**UK Head Office**

Pineapple House, Westmead,
Aylesford, Maidstone, ME206XJ

France

13 rue Louis Aragon, ZI La Vignasse,
07800 La Voulte sur Rhône

+44 (0)20 3904 6688

London Showroom

41 Pear Tree Street, Clerkenwell,
London, ECV 3AG

Leeds Showroom

Vitality House, Milford Place,
Leeds, LS4 2BQ

london@work-agile.com

USA

7015 19 Mile Road
Sterling Heights, MI 48314

Germany

Auf der Landeskrone 2,
57234 Wilnsdorf

work-agile.com