

workagile

MAKING SPACES AGILE

Huddlebox[®]

Edge



Specifications

+44 (0)20 3904 6688

london@work-agile.com

work-agile.com

Standard modules

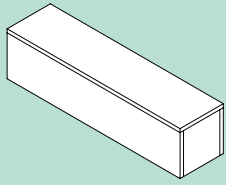

MODULE 1

Width: 900mm
Depth: 225mm
Height: 225mm

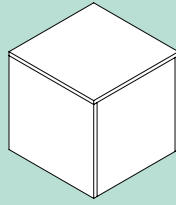

MODULE 2

Width: 450mm
Depth: 450mm
Height: 450mm

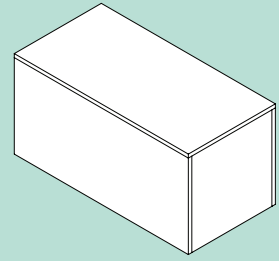

MODULE 5

Width: 900mm
Depth: 450mm
Height: 450mm

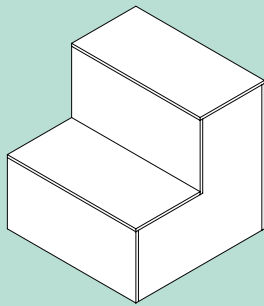

MODULE 9

Width: 900mm
Depth: 900mm
Height: 900mm

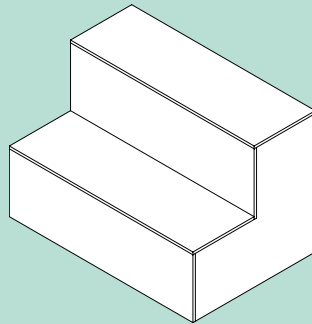

MODULE 9 LARGE

Width: 1350mm
Depth: 900mm
Height: 900mm

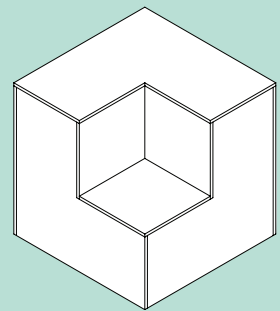

MODULE 10

Width: 900mm
Depth: 900mm
Height: 900mm

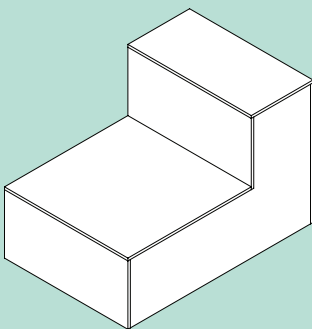

MODULE 11

Width: 900mm
Depth: 1350mm
Height: 900mm

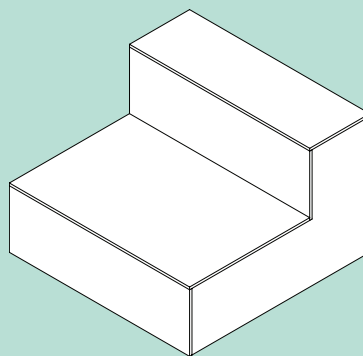

MODULE 11 LARGE

Width: 1350mm
Depth: 1350mm
Height: 900mm

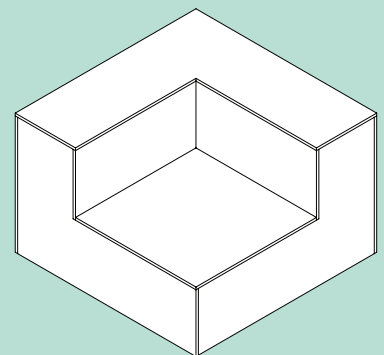

MODULE 12

Width: 1350mm
Depth: 1350mm
Height: 900mm

Planter modules

Supplied with plastic liner - suitable for real or artificial plants

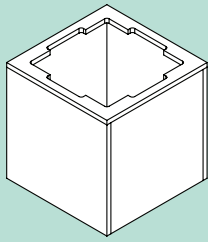

MODULE 2 PLANTER

Width: 450mm
Depth: 450mm
Height: 450mm

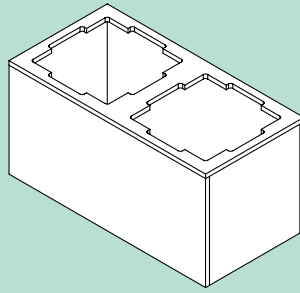

MODULE 5 PLANTER

Width: 900mm
Depth: 450mm
Height: 450mm

Cubby Modules

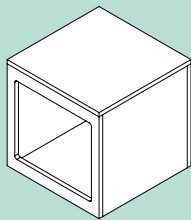

MODULE 2 CUBBY

Width: 450mm
Depth: 450mm
Height: 450mm

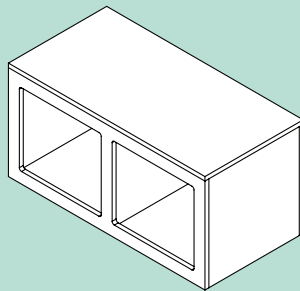

MODULE 5 CUBBY

Width: 900mm
Depth: 450mm
Height: 450mm

Seat Pads

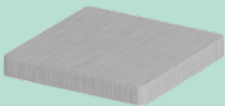

SINGLE SEAT PAD

400x400x50mm

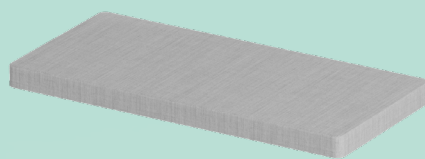

DOUBLE SEAT PAD

850x400x50mm

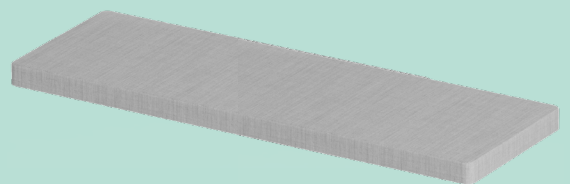

TRIPLE SEAT PAD

1300x400x50mm

Optional Extras

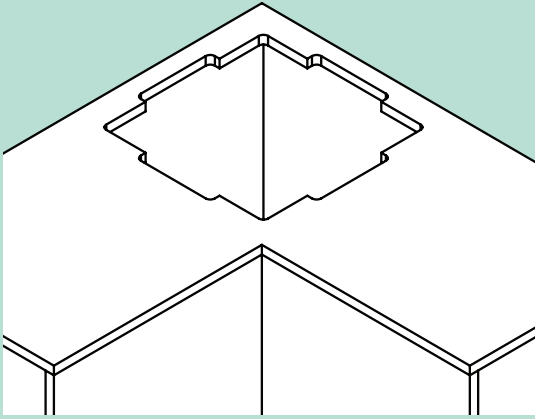

PLANTER CUTOUT WITH PLANT LINER INCLUDED

Biophilic designs bring nature indoors, promoting calmness

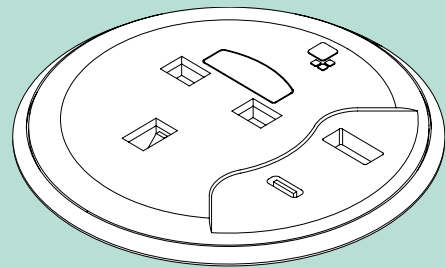

POWER MODULES

Stay powered up with an integrated power module.



CASTERS

Castors for easy moving and to protect flooring



ANTI-MICROBIAL SURFACE

Anti-microbial lacquer for extra safety and hygiene

Finishing touches

Ply Options

Our ply finishes enhance office wellness through a fresh, organic look and feel.



PLYWOOD

MFC Options

MFC is a cost effective construction option, with limited finishes available.



LIGHT GREY



ANTHRACITE



BLACK



BIRCH



LIGHT OAK

Seat Pad fabric options

Band 1

Camira	Auga	Inloom
Advantage	Juno	Alba
Era	Libra	Bondai
Gravity	Linetta	Erika
Manhattan		One
Phoenix		
Rivet		

Band 2

Camira	Auga	Inloom
Aspect	Aura UV	Jeans
Honeycomb	Cashmir	Jet
Main Line Flax	Nova	King Flex
Main Line Plus	Oregon Hyde	Milano
Oceanic		Riva
Xtreme		Roccia
X2		

Band 3

Camira	Auga	Inloom
24/7 Flax	Cord	Alba
Blazer	Finezza	Bondai
Halcyon	Pearl	Erika
Hemp	Verd Eco	One
Silk		
Synergy		

Band 4

Camira	Kvadrat
Synergy Quilt Channel	Canvas
Synergy Quilt Chevron	Divina 3
Synergy Quilt Hourglass	Fiord

For the complete range of fabrics, please email: london@work-agile.com or call us on 020 3904 6688, and we can advise a price.

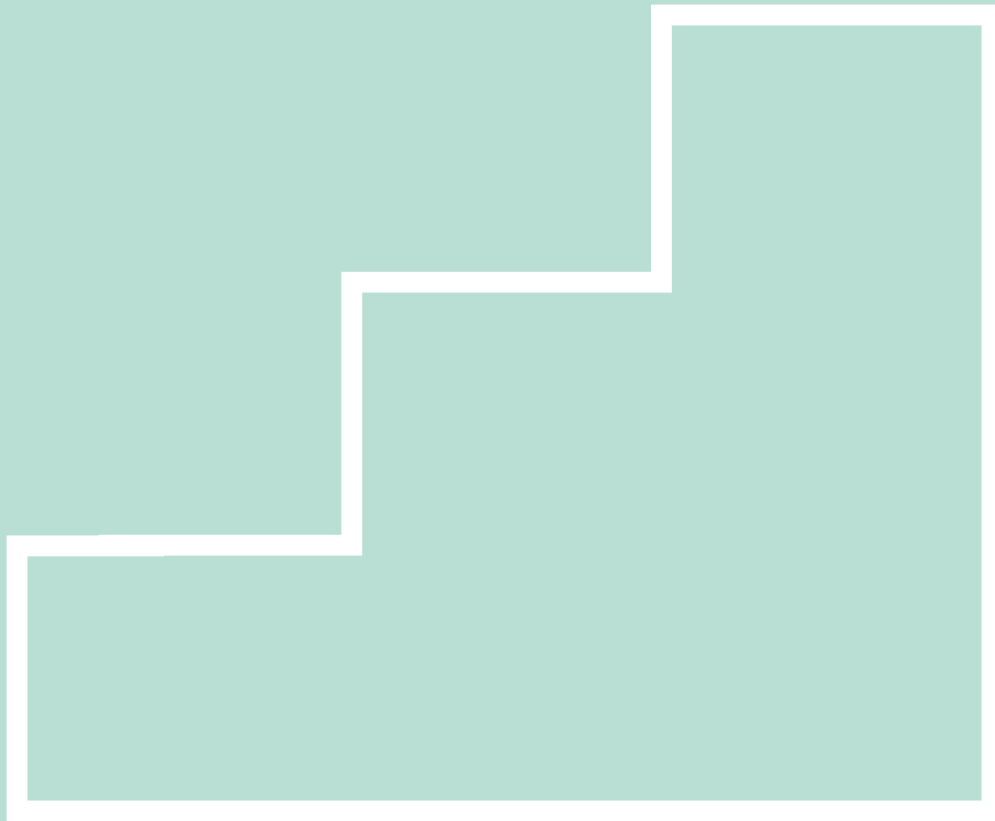

UK Head Office

Pineapple House, Westmead,
Aylesford, Maidstone, ME206XJ

France

13 rue Louis Aragon, ZI La Vignasse,
07800 La Voulte sur Rhône

London Showroom

41 Pear Tree Street, Clerkenwell,
London, EC1V 3AG

Leeds Showroom

Vitality House, Milford Place,
Leeds, LS4 2BQ

USA

2149 Avon Industrial Drive,
Rochester Hills, MI 48309

Germany

Auf der Landeskronen 2,
57234 Wilnsdorf

+44 (0)20 3904 6688

london@work-agile.com

work-agile.com